

1 DESCRIPTION

The MATRIX₁₂TM M Esophageal Temperature Probe provides continuous temperature measurement (°C) from 12 thermistors, located as shown in the illustration below, and operates in direct mode. Temperatures are displayed on the CIRCA Temperature Monitor. The MATRIX₁₂TM M Esophageal Temperature Probe may optionally be connected to a 3D cardiac mapping system as it is equipped with two pairs of electrodes to assist in visualizing the general location of the probe if connected.

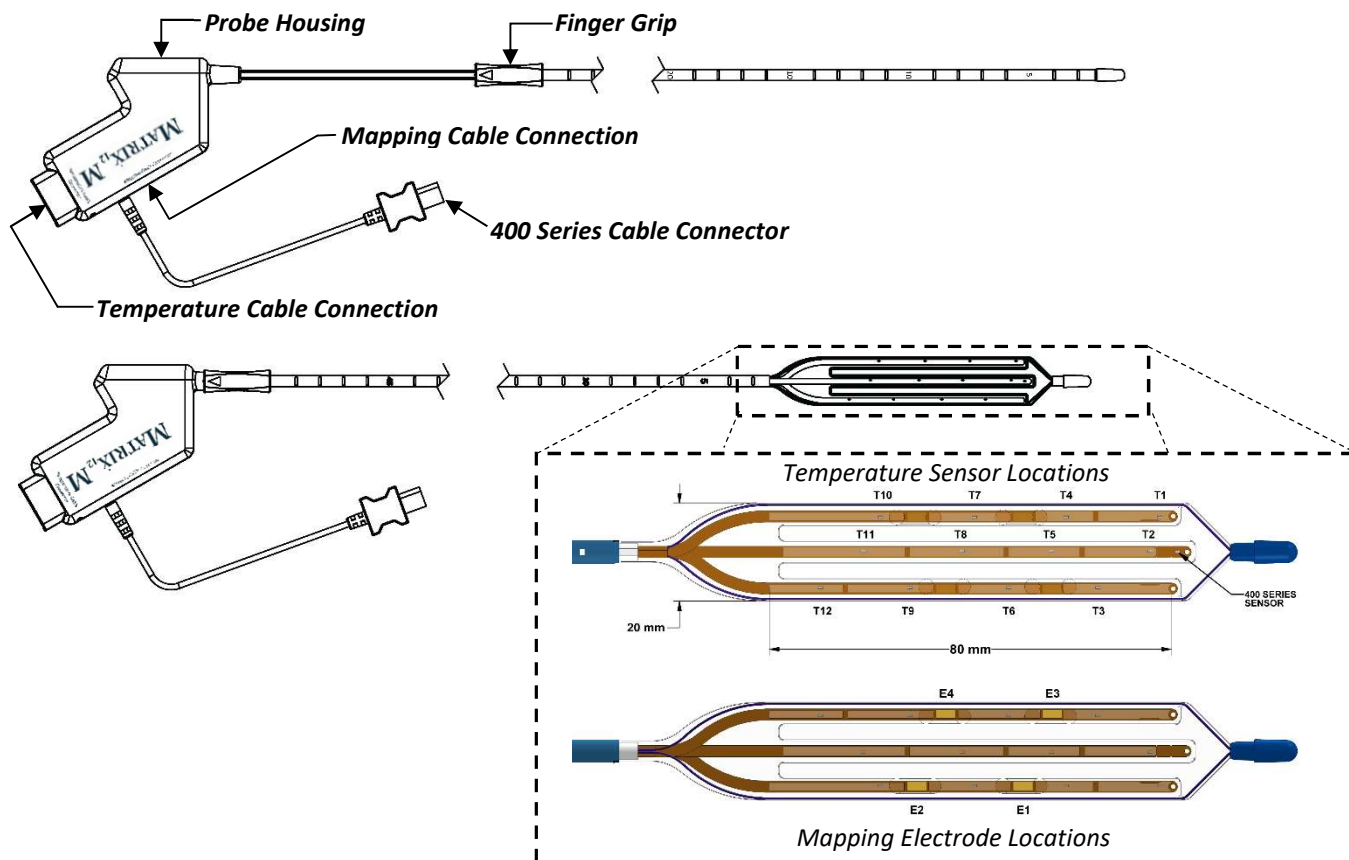

2 INTENDED PURPOSE

The Esophageal Temperature Probe is intended for continuous esophageal temperature monitoring during cardiac ablation procedures. The radiopaque probe is designed for placement in the esophagus and is equipped with electrodes that assist in visualizing the general location of the probe if connected to a 3D cardiac mapping system.

2A Clinical benefits: as this is a temperature-monitoring device, there can be no direct clinical benefits attributed to the device. The clinical benefits associated with the overall procedure are applicable to the device and can be used as the parameter to measure the performance of the device. In addition, ‘reduced risk of esophageal thermal injury’ can be considered as the indirect clinical benefit of the device.

2B Contraindications: do not use this device in patients with anomalies or disease of the nose, throat, or esophagus.

2C Limitations: device(s) should only be connected to the CIRCA Esophageal Temperature Monitoring System for temperature reading, but not other temperature monitoring systems.

2D Intended Users: the target user group is trained medical professionals. The probe is placed and used by a trained medical professional, e.g., surgical nurse, anesthesiologist, cardiologist, electrophysiologist, or ENT physician.

2E Intended Patient Population: adult male and female patients indicated as clinically suitable and in need to undergo cardiac ablation prescribed by a suitability qualified clinician.

3 GENERAL WARNINGS AND PRECAUTIONS [MATRIX₁₂TM M Esophageal Temperature Probe]

- Once package is opened, do not rinse, soak, wash, reprocess the esophageal probe. Reprocessing may compromise the structural integrity and/or lead to temperature inaccuracy or device failure which, in turn, may result in patient injury, illness, or death.
- Single use only. Do not re-use. Reprocessing may also create a risk of contamination of the device and/or cause patient infection or cross-infection, including, but not limited to, the transmission of infectious disease(s) from one patient to another. Contamination of the device may lead to injury, illness or death of the patient.
- Insert probe into esophagus using fluoroscopy to guide placement. Failure to verify placement could result in accidental tracheal or bronchial intubation, airway obstruction.
- During device introduction, care must be taken to avoid device migration into the trachea. Damage to the lung could occur should the device be introduced into the trachea/bronchial tree.



Manufactured for:
CIRCA Scientific, Inc.
14 Inverness Drive East, H-136
Englewood, CO 80112 USA
+1-303-951-8767

EU REP

MedNet EC-REP III GmbH
Borkstrasse 10, 48163 Muenster, Germany

CE 2797

CS-ART030 Rev. 02
(2026-04-24)
Page 1 of 4

- If any resistance is felt during device introduction, determine the cause of resistance and proceed only as appropriate. Do not use excessive force to advance or withdraw the catheter when resistance is encountered. Such resistance may lead to damage or perforation of the trachea or esophagus.
- The CIRCA MATRIX12™ M Esophageal Temperature Probe is designed solely for use with CIRCA Scientific Temperature Cable (CS-103), Mapping Cable (CS-100), CIRCA Scientific Temperature Monitor, 400 Series-compatible Temperature Monitor (not supplied), and compatible 3D Cardiac Mapping Systems (not supplied). Incompatible components can result in degraded performance and could lead to damage.
- Only equipment complying with the requirement of IEC 60601-1 for medical equipment patient protection should be used within the patient environment. Other equipment not complying with patient protection should only be used outside the patient environment.
- Additional equipment connected to the probe must be certified to respective IEC or ISO safety standards. When connecting external equipment to the probe, ensure that the whole combination complies with safety standard for Medical Electrical Systems according to IEC 60601-1 edition 3.2 (clause 16) and with the requirements of local laws and governing agencies. Hospital personnel who connect additional equipment configure a medical system, and are therefore responsible for the system complying with the requirements for Medical Electrical Systems.
- Location data obtained using the CIRCA MATRIX12™ M Esophageal Temperature Probe does not delineate the full width of the esophagus, the actual location of the esophageal wall, the location of individual temperature sensors, or the actual shape of the probe. Location data solely delineates the two outer edges of the probe matrix.
- Part of defibrillation proof protection is provided by the CIRCA MATRIX12™ M Esophageal Temperature Probe with the CIRCA Temperature Monitor (Defibrillation-Proof Type CF Applied Part). When CIRCA Mapping Interconnect Cable is connected to a 3D Cardiac Mapping System and/or when 400 Series Cable Connector is connected to a 400 Series Compatible Monitor, consult equipment manufacturer's accompanying documents for the monitor's defibrillation-proof classification.
- Do not use the device if any of the 12 temperatures displayed are meaningfully lower than 37°C (<35°C), in absence of particular justifying situations, or the displayed temperatures show a difference $\geq 2^{\circ}\text{C}$ is among the twelve displayed values.

4 POTENTIAL ADVERSE EVENTS

Potential risks for serious incidents associated with the use of the probe include:

- Infection
- Airway obstruction
- Lung damage or perforation
- Trachea damage or perforation
- Esophagus damage or perforation
- Epistaxis

Notice: any serious incident that occurs in relation to this device should be reported to CIRCA Scientific and the Competent Authority of the Member State in which the user is established.

5 SETUP INSTRUCTIONS

The operator is responsible for checking the compatibility of the MATRIX12™ M Esophageal Temperature Probe, CIRCA Interconnect Cables, and CIRCA Temperature Monitor before use. Ensure only the CIRCA Temperature Cable (CS-103) and the CIRCA Mapping Cable (CS-100) are connected to MATRIX12™ M Temperature Probe Housing.

(S1) Remove device from package.

(S2) Visually inspect for damage, kinks, visible debris, and missing components. Do not use if any defects are observed.

(S3) Proceed with connection and operating instructions below.

CAUTION: Do not use this device in patients with anomalies or disease of the nose, throat or esophagus.

If Using with a 3D Cardiac Mapping System to Assist in Visualizing General Location of the Probe, Define MATRIX12™ M Probe in 3D Cardiac Mapping System:

The MATRIX12™ M is equipped with 4 electrodes to assist in obtaining generalized location of the probe when connected to impedance-based 3D cardiac mapping systems.

Note: Probe has been tested for compatibility with CARTO 3 (Biosense Webster) and EnSite NavX (St. Jude Medical). If other equipment is used, the combination of the equipment, separation and possible leakage currents should be evaluated.

(C1) Before the procedure, define the MATRIX12™ M Probe as a custom catheter in the 3D cardiac mapping system per the 3D cardiac mapping system manufacturer's instructions for use.

(a) **EnSite NavX:** Define the MATRIX12™ M Probe as two straight probes using the following parameters:

	Number of Electrodes	Catheter Size:	Electrode Width:	2-pin Connector:	Distance between Electrodes
Probe 1:	2	10 Fr.	4.0mm	D and 2	22mm (Edge-to-edge)
Probe 2:	2	10 Fr.	4.0mm	3 and 4	22mm (Edge-to-edge)

(b) **CARTO 3:** Define the MATRIX12™ M Probe as two straight probes using the following parameters:

	Number of Electrodes	Catheter Size:	Electrode Width:	2-pin Connector:	Distance between Electrodes
Probe 1:	2	10 Fr.	4.0mm	D and 2	22mm (center-to-center)
Probe 2:	2	10 Fr.	4.0mm	3 and 4	22mm (center-to-center)

Note: Two pin boxes are required to connect the MATRIX12™ M Probe to the CARTO3 Patient Interface Unit (PIU). Please contact your 3D cardiac mapping system manufacturer to obtain the appropriate product code(s) and ordering information.

6 OPERATING INSTRUCTIONS

(O1) Insert MATRIX12™ M Probe into esophagus.

- If using with a 3D cardiac mapping system (not supplied), connect MATRIX12 M™ Probe to the Patient Interface Unit, CathLink module, or equivalent 3D cardiac mapping system component via the CIRCA Mapping Cable (CS-100). Ensure connectors are aligned and fully seated by pressing firmly. Connect Patient Interface Unit, CathLink module, or equivalent 3D cardiac mapping system component to the 3D cardiac mapping system according to manufacturers' operating instructions.
- Apply water-soluble lubricant to tip and blue shaft of probe to facilitate introduction.
- Introduce probe into esophagus via the oral or nasal passage. Advance distal tip of device to approximately 1 cm (0.4") superior to the gastroesophageal junction. Use fluoroscopy or 3D mapping system to guide placement as necessary.

Note: When introducing the device via the nasal passage, encouraging the patient to swallow when the probe reaches the oropharynx may aid the introduction of the device into the esophagus.

CAUTION: During device introduction, care must be taken to avoid device migration into the trachea. Damage to the lung could occur should the device be introduced into the tracheo/bronchial tree.

CAUTION: If any resistance is felt during device introduction, determine the cause of the resistance and proceed only as appropriate. Do not use excessive force to advance or withdraw the probe when resistance is encountered. Such resistance may lead to damage or perforation of the trachea or esophagus.

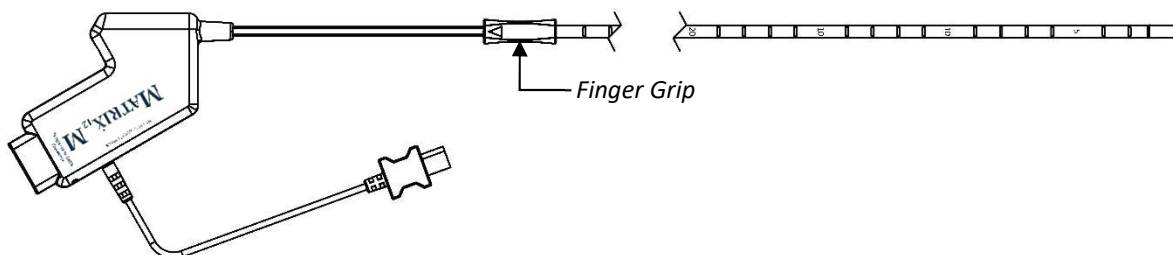

- Once probe is placed, grasp probe's connector housing with one hand and grasp finger grip with the other hand. Keeping probe in place, pull back until finger grip is seated on housing.

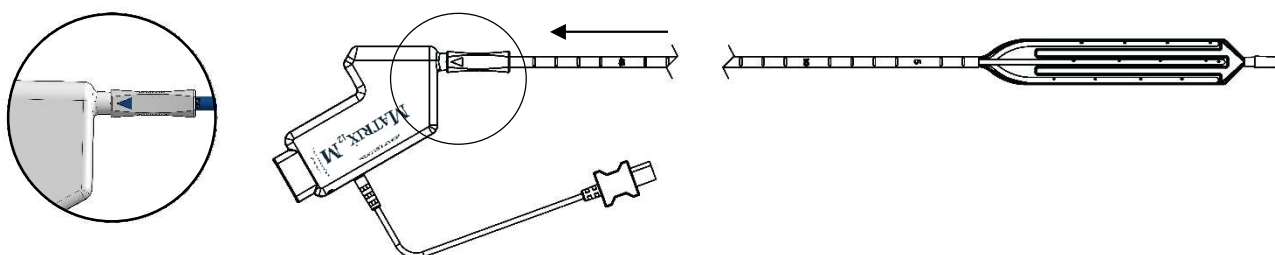

- Slowly withdraw the probe. If used with a 3D cardiac mapping system, observe the location of the device's electrodes on the mapping display, verify that the probe is placed at the desired location. Use fluoroscopy to guide placement as necessary.

- Location data delineates the outer edge(s) of the CIRCA MATRIX12™ M Probe.

Note: The electrodes are located along the outer edges of the deployed probe (adjacent to temperature sensors 3 and 9 and adjacent to temperature sensors 4 and 10 (see "Description" section above). Due to limitations of some impedance-based 3D cardiac mapping systems, only one probe may appear on the mapping display without utilizing additional equipment provided by the mapping system manufacturer. Location data obtained using the MATRIX12™ M Probe does not delineate the full width of the esophagus, the actual location of the esophageal wall, the location of individual temperature sensors, or the actual shape of the probe.















- If the probe does not appear or appears in an undesired location, the probe may not have been placed in the esophagus. If placed using a 3D cardiac mapping system, try troubleshooting the system as guided by the mapping system manufacturer. If that does not resolve the issue, use fluoroscopy as needed and consider removing and replacing the probe.

- (O2) Connect MATRIX12™ M Probe to CIRCA Temperature Monitor.
- (a) Connect MATRIX12™ M Probe to CIRCA Temperature Monitor via CIRCA Temperature Cable by aligning connectors and pushing firmly.
 - (b) If used, align 400 Series Cable Connector with 400 Series compatible temperature monitor cable, and push firmly to assure full contact.
 - (c) Verify temperatures are displayed on monitor. If no temperature displays, verify connections are fully seated, and resolve any error messages displayed on temperature monitor. See CIRCA Temperature Monitoring System User Manual for reading the probe temperatures and display settings.
- (O3) Disposition After Use
- (a) Disconnect MATRIX12™ M Probe from interconnect cables by grasping connectors and pulling apart.
 - (b) Remove probe from patient.
 - (c) Discard probe according to hospital’s disposal procedures.

7 TECHNICAL INFORMATION

Temperature Sensors (Sensors 1-12)	Accuracy of the temperature sensors and monitor is ±0.3°C within the rated output range of 10°C to 45°C and ±0.4°C within the rated extended output range from 0° to < 10°C and from > 45°C to 55°C.
Temperature Sensor (400 Series Thermistor)	Accuracy of the temperature sensor is ±0.3°C within the rated output range of 25°C to 45°C.
Outside Diameter	14 Fr
Electrical Safety	Meets IEC 60601-1:2005 + A1:2012 +A2:2020 when used with CIRCA Scientific Interconnect Cables and Monitor
Transient Response (Sensors 1-12)	Heating transient response time is approximately 1.7 seconds, and cooling transient response time is approximately 1.4 seconds. <i>Note: Time is for probe plunged from reference water bath to a water bath with a 2°C differential.</i>
Transient Response (400 Series Thermistor)	Heating transient response time is approximately 2.7 seconds, and cooling transient response time is approximately 2.2 seconds. <i>Note: Time is for probe plunged from reference water bath to a water bath with a 2°C differential. (Measured with a hand-held digital thermometer.)</i>
Electrodes	Width: 4.0mm. Distance 1 - 2 = 22mm. Distance 3 – 4 = 22mm.
Storage and Transport	Temperature: -20°C to 60°C (-4°F to 140°F). Humidity: 10% to 85% RH, non-condensing.
Natural Rubber Latex	Products and packaging are not made with natural rubber latex.

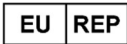
8 SYMBOLS KEY

 Medical device		Caution: Part of defibrillation-proof protection is provided by the MATRIX12™M Temperature Probe. Do not use with any other applied part.
 Catalogue number		Defibrillation-Proof Type CF Applied Part
 Lot number		Single use only. Do not re-use.
 Quantity		Consult instructions for use.
 Use-by date		Temperature limits
 Manufacturer		Humidity limitation
 Authorized Representative in the European Union		“Conformité Européenne” “European Conformity”

Patent www.circascientific.com/en-us/patents